

Main operation interface and screen

1. Interface display

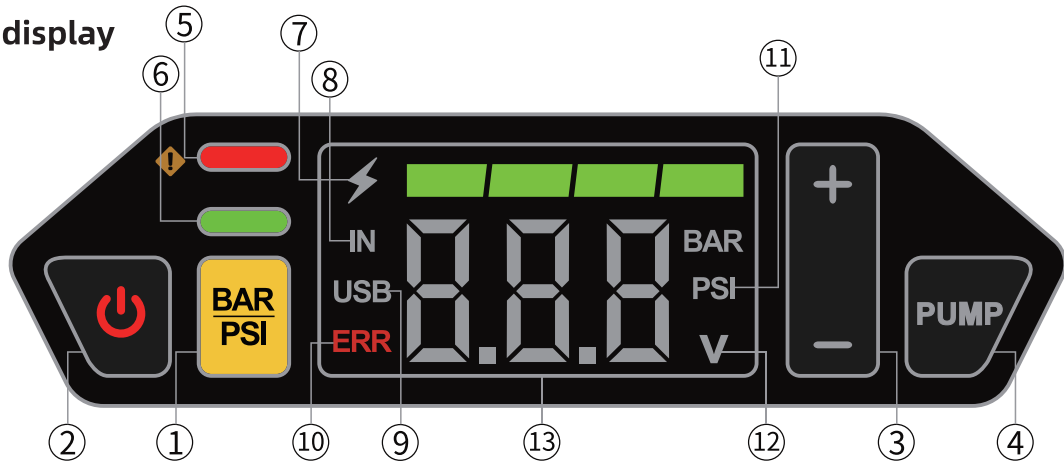

2. Description

No.	Functional Description	No.	Functional Description
1	BAR/PSI unit switch button, and it can also be used as a forced start function switch	2	Power button (Short press to turn on, long press for 2 seconds to turn off)
3	The button for presetting tire pressure: When the tire pressure is presetting, numbers will blink; The blinking will stop after the setting is completed. You may then exit the setting mode. At the same time, the real-time tire pressure will be displayed on the screen	4	Air inflator start-stop button: Hold down the button for 3 seconds to turn on. Press down quickly to turn off
5	Red light (Abnormal warning indicator for emergency jump start function)	6	Green light (ON: Forced start mode output; Blinking: Normal start mode output)
7	Battery indicator light (Power: 20%、40%、60%、80%、100%; Charging: Marquee)	8	IN: Charging status indicator
9	USB: USB Status Indicator	10	ERR: abnormal state alarm indicator
11	BAR / PSI: Tire pressure units setting indicator light	12	V: Output voltage detection status indication and units
13	Numerical display area		

Operating Procedure

1. How to power up the jump starter?

Press the "Light" or "Power" button

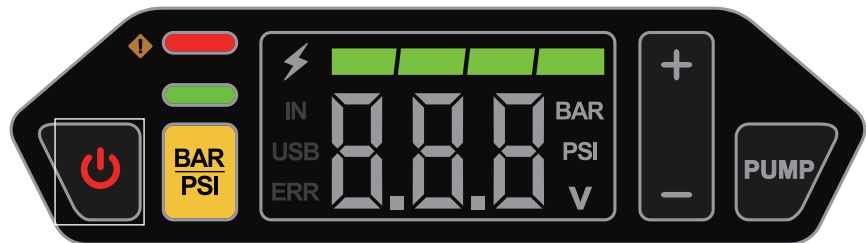
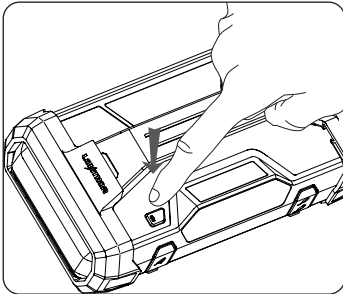

2. How to use the jump-start function?

2.1 Method one: Normal start

2.1.1 Connect the jump starter clamps with the EC8 connector to the jump starter.

2.1.2 Connect the red (+) clamp to the positive (+) terminal on the vehicle battery and the black (-) clamp to the negative (-) terminal on the vehicle battery, and make sure that the connections are good.

2.1.3 Press the "Light" or "Power" button to power on the product. The green light on the screen will light up and flash if there are no issues. At this time, you'll be able to start your vehicle.

2.1.4 If the vehicle starts successfully, the jump starter will automatically disable the power output.

2.1.5 In most cases, the vehicle will be able to start immediately after the jump starter has been connected. Some vehicles may need to be connected to the jump starter for 30~120 seconds (the product will charge the car battery at this time) to continue the operation. If the vehicle does not start immediately, Please wait 20-30 seconds before each attempt. Do not attempt more than five times within 15 minutes.

2.1.6 Please remove the jump-start clamps from the car battery instantly after you finished the starting. Pressing on the "Power" button for 2 seconds to shut down jump starter. If there are no operations for 60 seconds, the product will automatically shut down.

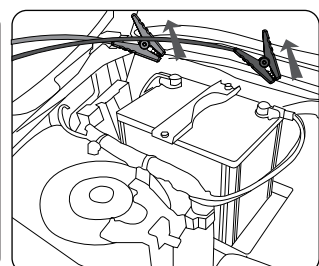
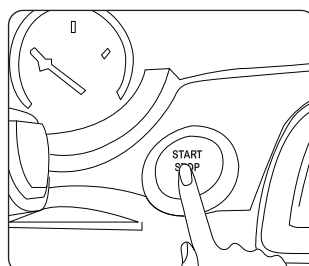
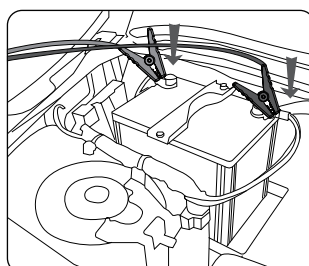
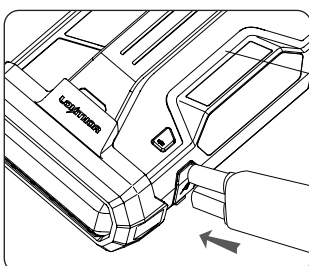

2.2 Method two: Forced start

(Safety reminder: Under the forced start mode, part of the safety protection mechanism is invalid. Be sure to connect the positive and negative poles correctly, otherwise it will cause a short-circuit. So please check the instruction manual before operation and use with caution)

2.2.1 At this time, the normal start mode fails to start , e.g: the voltage of the car battery is very low (the voltage is less than 1V),you can use the forced emergency start function after checking the operating specifications in the manual;

2.2.2 Connect the jump starter clamps to the EC8 connector on the Jump-Starter;

2.2.3 When the jump starter is on, tapping and holding on the "BAR/PSI" button for 5 seconds will enter the forced start mode. At this time, the green light on the screen is always lighting, which means that the output of the ignition clips are normally turned on. At this time, you must prevent the positive and negative poles from being short-circuited; (In this mode, it is required to turn on the forced start function first, and then connect the ignition clips to the car battery, otherwise the output cannot be turned on);

2.2.4 Connect the red (+) clamp to the positive (+) terminal on the vehicle battery and the black (-) clamp to the negative (-) terminal on the vehicle battery(during the connection process, there will be a slight sparking phenomenon, which is normal) and make sure that the connections are good; At this time, the overall voltage of the jump starter connected in parallel with the vehicle is displaying on the screen, then you can jump-starting the vehicle;

2.2.5 Shortly press the "Power"  or "BAR/PSI"  button to exit.

3. How to use voltmeter function

3.1 Connect the jump starter clamps to the EC8 connector on the Jump-Starter;

3.2 Connect the red (+) clamp to the positive (+) terminal on the vehicle battery and the black (-) clamp to the negative (-) terminal on the vehicle battery, and make sure that the connections are good;

3.3 At this time, the green light on the main interface flashes, and the overall positive and negative voltages of the starting power supply connected in parallel with the car are displayed at the same time, and it enters the starting mode. To check only the voltage of the car battery, short press the "ON" button to exit the starting mode and enter the measurement Mode, the "green light" goes out, the display only displays the voltage value of the car battery, so as to determine whether the battery is damaged;

3.4 Disconnect the alligator clamps from the vehicle battery and exit the voltmeter function mode.

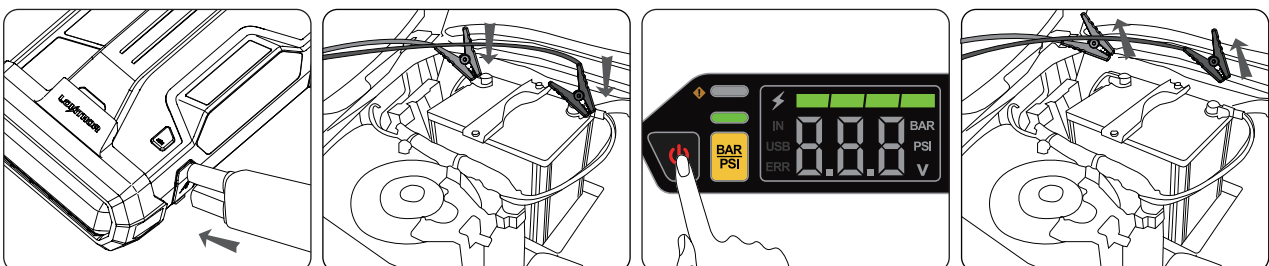

4. How to use the air inflator function?

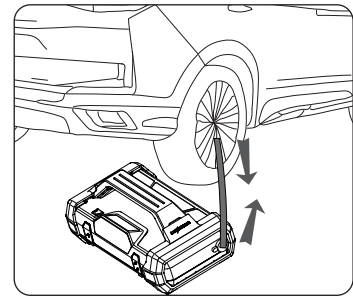
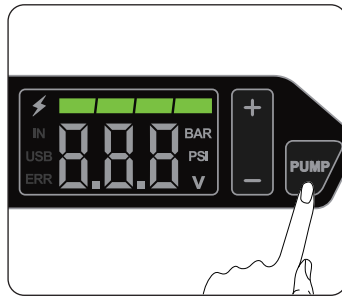
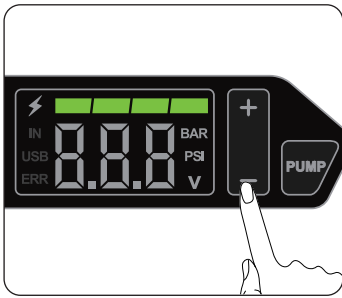
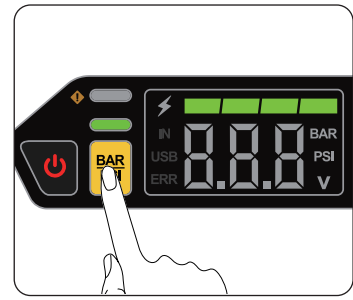
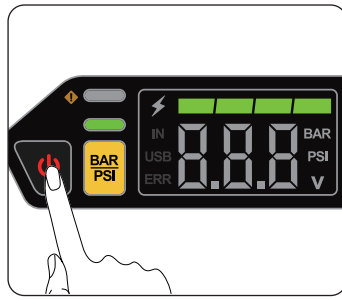
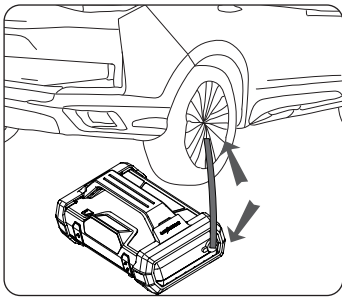

4.1 The inflatable hose is connected to the output port of the air inflator, and then tighten the nut, and the other end is connected to the car tire;

4.2 To wake the product (short press the "Light" button or short press the "Switch" button) to enter the air inflator mode;

4.3 Short press the "BAR/PSI" button to switch the pressure unit of tire pressure: BAR, PSI;

Pressure conversion table	Unit	Bar	kPa	PSI	Kgf/cm2
	Value	1	100	14.5	1.02

4.4 To set the target tire pressure value, you must first know the tire pressure requirements of the tire. (For the standard tire pressure value of the tire, you can check the pressure value mark on the tire, or check the manual of the inflated product), set the target tire pressure value by pressing "+ -". After setting, the value will flash for 3 seconds, exit the setting state and enter the real-time monitoring state of tire pressure;

(Safety reminder: If the target tire pressure value of the tire is not set, directly turn on the air pump. At this time, the air pump will not automatically charge and stop. It needs to be turned off manually. If the tire pressure is not monitored in real time, there will be The risk of excessive tire pressure or puncture)

4.5 Long Press the "PUMP" button for 3 seconds to turn on the air inflator. When the tire pressure reaches the set value, the air inflator will be turned off automatically. To turn off the inflator manually: press the "PUMP" button or the "Switch" button;

4.6 Remove the inflatable hose.

(Safety reminder: During the inflation process, the heat generated by the air inflator will cause local high temperature. Please leave the product for 10 minutes to dissipate heat before removing the inflation tube to prevent scalds)

5. How to use LED light?

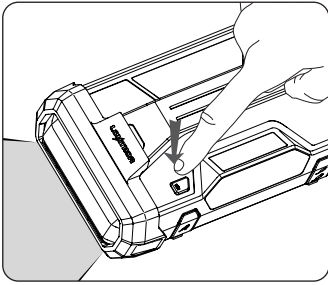

- ① Long press the "Light" button for one second, the LED lights up;
- ② Short press the "Light" button in order to switch the modes of ON, Strobe, SOS and OFF;
- ③ Long press the "Light" button for two seconds to turn off the LED light forcefully.

6. How to charge your jump starter

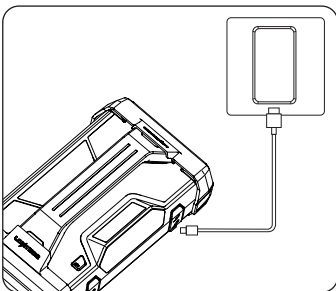

6.1 You will need the following: USB power adapter(5V output USB power adapter or 9V2A USB power adapter if QC protocol supported) and a USB To Type-C cable.

6.2 Plug the USB plug/A Port into the power adapter and the C port into the jump starter's charging port. At this point, the battery indicator and the "In" icon on the screen will turn on, indicating that the product is charging.

6.3 In the case of running out of power or low power, please charge the product in time to prevent battery under-voltage. Long-term no power status of battery may cause the product to fail to charge.

7. How to use the 5V USB-A port to charge your mobile phone

7.1 You will need the following: USB To USB-C cable and a mobile phone (if the mobile phone supports 9V2A of QC protocol, it can support 9V2A fast charge);

7.2 When the "USB" icon on the screen light up, plug the USB plug/A Port to the jump starter and the C port into your mobile device.

